

Varenummer: 3901150010400
 Beskrivelse: Snekkegear med fri indgangsaksel
 VF 150F-10-HS

Mål

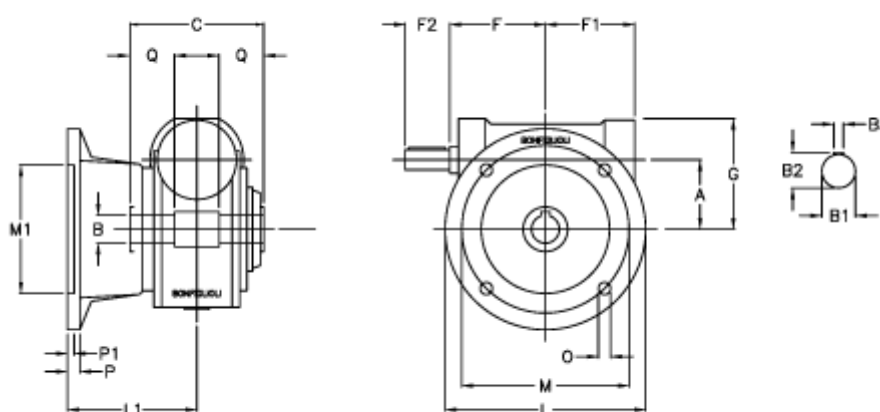

a	= 150.0	F1 = 179	P = 22
B	= 50	F2 = 65	P1 = 20
B1	= 35	g = 218	Q = 55.0
B2	= 38.0	L = 350	
B3	= 10	L1 = 220.0	
Betegnelse	= VF 150F-xx-HS	m = 290	
C	= 175	M1 = 200	
F	= 185.0	O = 18.0	